









## Green 50x37

<b>Descrizione</b>	cm 50x37 kg 23 lt 4,5	Wc sospeso con sistema di scarico Silentech e sistema di fissaggio a scomparsa dal basso.
<b>Codici, colori e finiture</b>	<b>04 1150 0001</b> (ex.1VS50RGR00)	Bianco lucido <input type="radio"/>
<b>Plus e caratteristiche</b>	 Silentech  Save Water  Cataglaze+  Soft Close  Quick Release  CE EN 997 - CL1 - 5A	

### Dimensioni

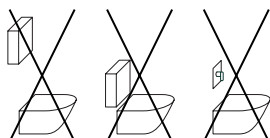
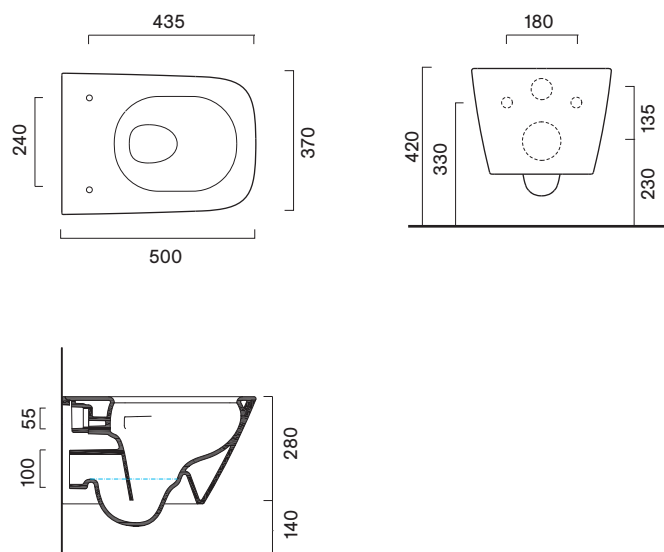

É sconsigliato l'abbinamento con cassetta alta, sottofinestra e flussometro.